

Step 1 Design your fence

Have the local utility companies mark your underground lines. On a sheet of paper, draw your house and yard. Draw a line around your property that represents the containment area for your dog.

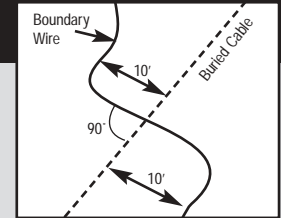

Step 2 Install the wall-mount transmitter

Most people find that the inside of an exterior wall of a garage or basement is ideal. From the sample layouts included, you can see the twisted wire running from the house attaches directly to the transmitter.

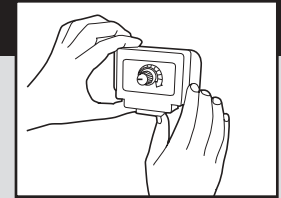

Step 3 Layout the fence wire

Run the containment wire around the property as outlined in your plan.

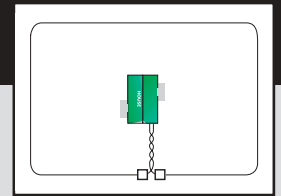

Step 4 Final connections

Splice the containment loop wires to the twisted wire using the supplied waterproof splices. Connect the other end of the twisted wire to the wall-mount transmitter. Plug the AC adapter, connect it to the transmitter and turn it on. The red light should illuminate on the transmitter indicating a successful loop.

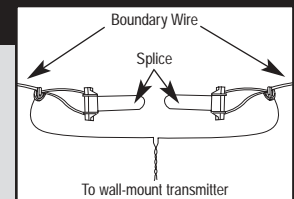

Step 5 Power Up

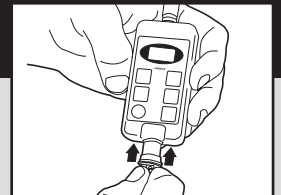
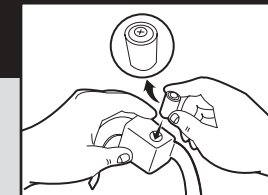

For all systems, install batteries positive side out as shown. For Contain 'N' Train systems, please refer to the "Match Receiver" section on page 9 of this guide.



Invisible Technologies, Inc.
800-826-5527
www.innotek.net

Step 6 Test your fence

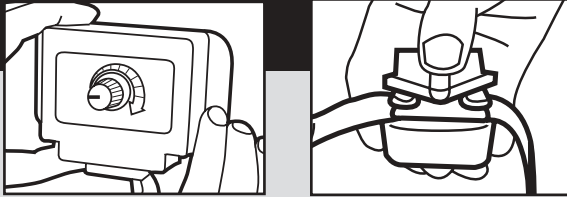

Set your FIELD WIDTH ADJUSTMENT KNOB to the 9 o'clock position. Using the supplied test light, walk the dog's collar up to the fence wire. **NOTE:** For Contain 'N' Train Systems collar must be set to containment. Listen for the warning tone and look for the test light to light. Try a number of different places around the fenced area, in order to verify the range is consistent.

Step 7 Bury fence wire

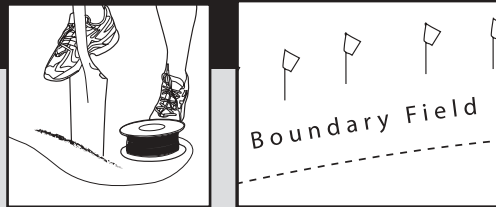

Dig the trench 3" deep with a flat edge spade. Or, it is faster to use a gas-powered edger. Digging the trench at an angle helps keep the wire in the ground as you place it. Place Flags at edge of selected boundary field, where the warning tone is first heard NOT at the wire.

Step 8 Train your dog

Watch the training video and follow the training steps outlined in the separate Training and Troubleshooting Guide. You may see your dog respond immediately to the training, however continue to follow the inclosed Training Guide to fully train your dog. The convenience that your new fence offers plus the added safety for your dog are well worth the time invested.

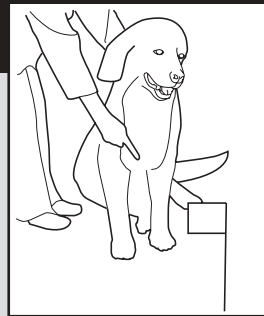

IMPORTANT ADVICE

1. Read the complete manual and follow all directions. This includes the Training & Troubleshooting Guide. If you have any questions, please call 1-800-826-5527.

2. This device is intended for use only on dogs. Never attempt to use it for any purpose not described in this manual.

3. Never perform set-up procedures while the collar is on your dog.

4. Any collar worn for extended periods can cause a condition similar to bedsores, known as Pressure Necrosis. To reduce the possibility, you must do the following:

- Never leave the collar on the dog for more than 12 hours per day.
- Check the fit to prevent excessive pressure; you should be able to insert one finger between the collar strap and your dog's skin.
- Examine the dog's neck daily for any signs of a rash or a sore.
- Wash the dog's neck area and the probes of the collar weekly with a damp cloth.
- If the condition persists beyond 24 hours, see your veterinarian.

5. Always use the rubber insulators between the collar strap and probes to provide insulation in damp conditions.

6. Other collars and metal tags should be removed as they may interfere with proper operation.

7. Do not attempt to dismantle or repair any components of this system; doing so will void the warranty in full. The computerized circuitry should be serviced only by an authorized expert.

8. Realize that because dogs have unique temperaments, there is no way of knowing how your dog will react to the introduction of a training collar system. For the safety of your dog, a long lead should be used during initial training so you have control of the situation.

9. If you have reason to believe that your dog may pose a danger to others, harm itself, or react adversely to the collar, do not rely solely on this product to train your dog. If your dog shows signs of growling, snarling or biting while using the collar, stop immediately. Aggression in dogs has many causes. We recommend that you consult a knowledgeable professional dog trainer or animal behaviorist with experience with aggressive dogs if your dog has shown any of these characteristics.

10. Occasionally, a dog cannot be trained to respond to a training collar. Sometimes even a properly trained dog may disobey a command. Therefore,

Invisible Technologies, its distributors, and dealers cannot guarantee that the system will in all cases keep the customer's animal from disobeying commands.

LIMITED LIFETIME WARRANTY

WE CARE. CALL US FIRST. 1-800-826-5527

Invisible Technologies, Inc., warrants to the original retail purchaser, that Innotek brand products will be free from defects in material and workmanship, under normal use, for a period of one year from the date of the original retail purchase. This Limited Warranty excludes: accidental damage due to dog chews; lightning damage where an INNOTEK lightning protection component is not in use (in-ground pet fencing systems); or neglect, alteration and misuse.

Invisible Technologies offers several product exchange options during the warranty period. If service is required, call 1-800-826-5527 to discuss the service plan that best serves your needs. Costs are dependent on the processing time and the desired shipping options. Please do not return this product to your retailer.

After one year from date of original retail purchase, we will repair, replace or upgrade your product at a fixed rate based on the component.

Invisible Technologies, Inc., shall not be liable or responsible for any incidental or consequential damages resulting from the use of the product or caused by any defect, failure or malfunction of the product, whether a claim is based upon warranty, contract, negligence or otherwise.

FREE Professional Training Support

Additional behavior or training issues? Looking for the best way to get a well-behaved dog? Just call our **FREE** Professional Training Support hotline at 1-800-364-3362 and speak with the professionals at Dogstar Training.

Visit www.partnersinbehavior.com

Smart Dog In-ground Pet Fencing System

Models SD-2000, SD-2050, SD-3000, SD-3100

THE COLLAR RECEIVER

The collar receiver is attached to a nylon collar strap that your dog will wear. The collar receiver administers the warning tone and correction should your dog attempt to leave the yard.

Fitting the collar on your dog.

The collar strap should fit snugly towards the top of your dog's neck with the collar receiver box on the bottom of the neck. You should be able to get one finger between the collar strap and your dog's neck. The contact points must make contact with the dog's skin for proper operation. A little hair thinning may be required.

Important Notes:

- A. Always use the rubber insulators and the collar strap. They provide insulation in damp conditions and keep the collar receiver secure.
- B. A small amount of hair thinning or removal makes contact with the dog's skin easier.
- C. This product is recommended for dogs six months of age and older.
- D. Occasionally, check the tightness of the receiver probes to ensure the receiver does not fall off of the collar. Lost collars are not covered under your warranty.

The Hand-held Transmitter (SD3000, 3100 only)

The transmitter has four preset levels of stimulation. Button 1 delivers the mildest level and button 4 the most intense. The collars will stimulate for as long as you hold the button down (10 seconds max).

When your system is set to the dual Contain and Train mode, the collar has a fence release mode. If you press and hold the PROGRAM button, you will hear a tone coming from the collar. The fence will be disabled for 20 seconds before resuming normal function.

SD-3000 only

The GOOD tone and BAD tone buttons are located on the front of the transmitter. When the GOOD button is pressed a reward tone sounds and can be followed up with praise or treats to reinforce the proper behavior. The BAD button is pushed to warn the pet prior to using any of the stimulation buttons.

OPERATING MODES (SD-3000 & SD-3100 Only)

Your Contain N' Train System can operate in three different modes. These different modes are indicated by the light status on the collar receiver.

- a. Containment mode only: No Light
The collar will only work with the containment portion of your system. This is the default mode after batteries are installed. To conserve battery life, it is best to keep the collar in containment mode only when the training system is not in use.

- b. Training mode only: Green Blinking Light
The collar will only respond to the hand-held training transmitter.
- c. Contain and train mode: Alternating red and green lights
This mode enables both the training and containment functions of your system.

Low battery status is indicated by a slow red blinking light. New batteries should be installed at the earliest possible time.

Battery Life of 3-Volt Lithium Battery in Collar Receiver	
Containment Mode	2 Months
Training Mode	300 Hours
Dual (Contain and Train) Mode	250 Hours

To select an operating mode, briefly touch the red paper dot on the collar receiver to the red paper dot on the hand-held transmitter. The collar receiver buzzes to tell you that a mode has been selected. By repeatedly touching the red paper dots together, you can cycle through the operating modes, each of which is identified by a specific light on the collar receiver.

THE WALL-MOUNT TRANSMITTER

The transmitter is the system's control center. The transmitter sends a coded radio signal around the containment wire you will install.

1. Field Width Adjustment- Controls the distance from the wire your dog can venture before hearing the warning tone.
2. Internal Lightning/Surge Protection- Protects transmitter from power surges or lightning strikes near the boundary wire.
3. Stimulation Level Jumper-(Models SD-2050 and SD-3100 only) Select from levels Low, Medium or High. The correction level your dog will feel after the 2-second warning tone (low and medium only). The tone will sound immediately with the correction when level is set on high.
4. Loop Wire Terminals- Connections for the containment wire.
5. Power Connection - Power for the containment system supplied by the 12 volt adapter plugged into any 110v outlet.
6. Power- Turn FIELD WIDTH KNOB counter-clockwise for ON/OFF Switch.
7. Yard Size Jumper- For system installations using 1,000 feet or more of wire (Your system comes with 500 FT): Remove four screws on front of transmitter. There are jumper pins on the right side of the circuit board, move the jumper to cover the pins next to the words LARGE.

The jumper must be installed for the system to operate.
8. System Indicator Light: System operating normally when on. OFF indicates a malfunction.

IMPORTANT:

Invisible Technologies recommends that you unplug the transmitter and disconnect the fence wire during lightning storms.

EXTERNAL LIGHTNING PROTECTOR

An External Lightning Protection Module helps protect the transmitter from electrical power surges and lightning strikes near your boundary wire. A nearby lightning strike can cause damage to your transmitter. Enhanced lightning protection is available for all Innotek containment systems by calling Invisible Technologies at 1-800-826-5527. Lightning damage is not covered under your product warranty unless external lightning protection is being used.

Stimulation Settings

SD-2000 & SD-3000 Systems Only

The stimulation is pre-set at the factory for optimal performance. Should your dog enter the containment field she will hear a two second warning tone. After training she will know to back into the safe part of the yard. By moving forward or staying in the same place, the collar will deliver a continuous level of stimulation until she moves back into the yard.

Over-Stimulation Prevention- In the unlikely event that your dog becomes "trapped" in the containment field, this feature limits stimulation duration to 10 seconds. The system shuts off for 10 seconds before resuming stimulation for another 10 seconds. This pattern will repeat for a maximum of three cycles, a duration of 60-seconds.

Run-Through Prevention- special features are incorporated in your system so your dog cannot "run-through" the containment field without activating a strong stimulation. The receiver automatically increases the stimulation when your dog continues more than 1/3 of the way through the containment field, regardless of the transmitter stimulation level setting. For example, if the signal is detected 12 feet from the wire and your dog enters the containment field, this feature is activated when he is approximately eight feet from the wire. At this point, your dog automatically receives the highest level of stimulation.

Step 1 Design your fence

- Although the containment wire is only buried 1" - 3" make sure you contact your utility companies to mark underground cables and wire before you dig.
- The containment wire must form a complete loop from the transmitter.
- For your dog's safety, it is recommended that you keep the containment wire at least 10' from the street.
- Keep in mind that you will want to place the wire where there is room for an 8'-12' containment field.
- Interference can occur around large metal objects and buried electrical, telephone and cable TV wires. Do not run closer than 10' to these cables. You can minimize interference issues by crossing perpendicular to these lines.

Front and Back Yard Loop

The most common installation. The wire is placed just inside the property line to form a square or rectangle.

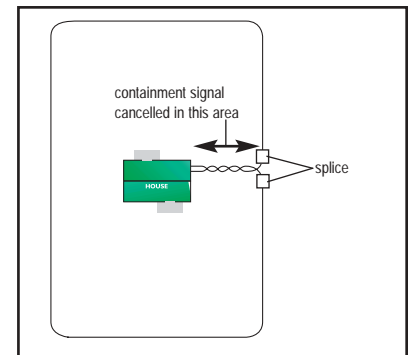

Front and Back Yard Loop

Hourglass Loop

Allows your dog to be contained in either the front or back yard but not around the side of the house. When the wire runs parallel to itself, as it goes toward the side of the house, be sure the wires don't come within 6' feet of one another to avoid canceling the signal.

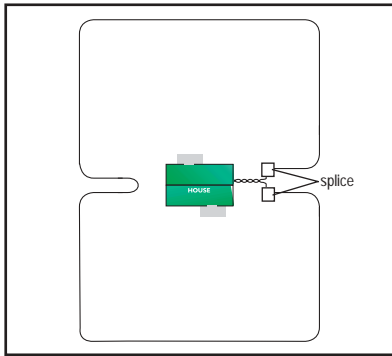

Hourglass Design

Double Loop

Confines your dog to the backyard only. The wire needs to run around the backyard, using the house as a natural barrier and doubling back to the transmitter to finish the complete loop. When doubling back, make sure that there is at least 6' between the lines to avoid canceling the signal.

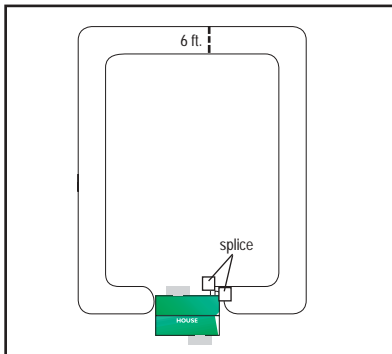

Double Loop

Customized Loops

You can create off limit areas, such as pools and gardens by encircling the area with wire. Run twisted wire from the fence loop to the encircled area and splice the ends together.

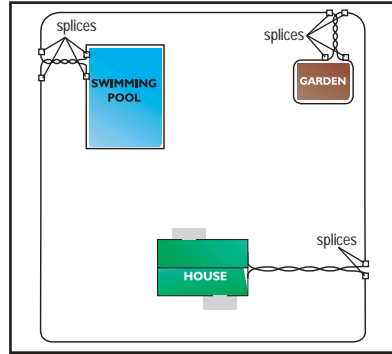

Customized Design

Step 2 Install wall Transmitter

1. Select a Location

Select an indoor, dry location to hang the wall-mount transmitter. You will need a standard 110v grounded outlet within 5 feet for power. Most people find the inside of an exterior wall of a garage or basement works well. You will need easy access to run the containment wire outside.

2. Hang transmitter on wall

Using the screw holes on the side of the transmitter as a template, mark location of holes with a pencil. Make sure the transmitter hangs straight and install using supplied screws.

3. Provide for wire access to outside

You will need to get the wire from the transmitter to outside where the containment loop will run. This can be done through a window or you can drill a 1/4" hole at the base of the wall to pass the wire through. After final installation and testing is complete you can caulk the hole to prevent water and insects from entering.

Step 3 Layout fence wire

With the transmitter installed and the hole drilled for the wire, you can position the boundary wire that will form your fence. DO NOT bury the wire until you are sure that the system is running properly.

1. Amount of wire.

Your system includes 500 feet of boundary wire. The SD-2050 includes 100 feet of pre-twisted wire. For larger areas, boundary kits with wire and splices, as well as convenient pre-twisted wire are available from your retailer or call at 1-800-826-5527. Here are some examples of wire coverage area:

Acres	Linear Feet Needed
1	850
2	1200
3	1500
4	1700
5	1900

2. Placing the wire

The wire must make a continuous loop from the transmitter and back again. The signal is transmitted from one terminal at the transmitter around the loop and back to the transmitter again. Keep in mind that you will want an 8' - 12' containment signal field from your wire, so don't run the wire too close to the house and make passageways too narrow for your dog to pass.

3. Twisted Wire

Twisted wire cancels the radio signal coming from your transmitter. This enables proper installation and your dog can cross over the wire in the safe part of the yard. Where there is single wire, the fence is active and your dog will be unable to pass. Your kit may have come with FasTrak pre-twisted wire or you can purchase it as a separate kit by calling 1-800-826-5527. You can twist your own wire by cutting two equal lengths of wire supplied and twisting them together. Anchor one end of the wires to something secure and insert the other end in a drill. Pull wire taught. The drill enables you to twist the wire quickly. You will need at least 12 twists per foot to effectively cancel the radio signal.

4. Rounding Corners

Use gradual turns at the corners with a minimum of 2.5 foot radius. This will produce a more consistent containment field.

Step 4 Final connections

IMPORTANT TIPS!

- DO NOT run wire within 10 feet or parallel to cable TV, phone and electrical lines. The signals can couple together causing collar activation in the house and safe parts of the yard.
- The wire must form one continuous loop from the transmitter.
- Use twisted wire to run between the transmitter and interior loops around pools and gardens to allow your dog to safely pass around these areas. (As illustrated in the custom loop pictures).

1. Splicing to the boundary wire.

Pull the twisted wire to the perimeter location of the two ends of your boundary wire loop. Splice the ends of the twisted wire to the ends of the boundary wire with the supplied waterproof splices. Use only waterproof splices supplied with this system. Additional splices are available by calling 1-800-826-5527. Use of wire nuts alone, electrical tape or solder will not provide a waterproof and secure connection for your system to function properly.

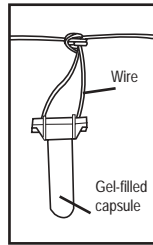

To use the gel-filled capsule splice, strip 5/8" of insulation from the wire ends. Insert ends of wire into nut and twist to secure. Insert the wire nut as deeply as possible into the waterproof gel and snap the lid shut. Tie a knot in the wires as shown to avoid having the wires pulled free during installation.

2. Bring outside wire to transmitter

From the outside, push the twisted pair of wires through the hole in the wall. Strip about 5/8" of insulation from the two ends. Insert ends into loop wire terminals marked on the transmitter (one in each terminal).

3. Plug transmitter in

Use supplied adapter and plug transmitter in. Turn transmitter knob to on position.

The red light should illuminate on your transmitter indicating a properly installed boundary loop. If the light does not come on, refer to the Training and Troubleshooting Guide included with your system.

Step 5 Power up

1. Install batteries. (All Systems)

Unscrew collar battery cap turning counter clockwise. Insert battery with the + facing out toward the battery cap. Carefully screw battery cap on and ensure it is seated straight. **Containment only** system owners can now skip to "Test your fence" section on the next page.

2. Match receiver to hand-held transmitter (SD-3000 & SD-3100 only)

To use the collar receiver in training mode or dual contain/train mode the collar receiver must be matched to the hand-held transmitter. This allows the signal from the hand-held transmitter to be compatible with the collar receiver. This process must be completed each time battery is replaced in either the receiver or the hand-held transmitter.

A. Insert battery in hand-held transmitter.

The battery cap is located on the bottom of the transmitter. Open by turning the lanyard ring counter clockwise. Insert the battery with the + terminal facing toward the opening.

B. Replace the battery cap turning clockwise ensuring it is seated straight.

PROGRAMMING

3. ID Codes

In the event there is another training device being used in the area, your collar receiver's ID code can be changed to any number of 2048 codes to avoid random activation. If you have the SD-3100 system for two dogs, you will need to repeat the process below for both dog one and dog two.

- Press and hold the PROGRAM button on the back of the hand-held transmitter.
- Continue holding PROGRAM button and press and hold BUTTON 1 on the front.
- Release the PROGRAM button and continue to hold BUTTON 1.
- The light on the hand-held transmitter will alternate red and green lights.
- When the lights stop blinking release BUTTON 1.
- Your hand held transmitter has randomly selected a number up to 2048.

2. Tone Options

Three tone options are available from the hand-held transmitter.

- Warning tone with stimulation
- No warning tones
- Warning tone with a one second delay

To set tone option on SD-3100 with two dogs, you must repeat the following instructions for dog one and two.

a. Press and hold the PROGRAM button on the back of the hand-held transmitter.

b. While holding the PROGRAM button, press and hold one of the following buttons to make your tone option selection:

BUTTON 2 = Tone with stimulation

BUTTON 3 = No Tones

BUTTON 4 = Tone with a one second delay

c. Release PROGRAM button and continue to hold button 2, 3 or 4. You will get a solid light then it goes out.

d. Release BUTTON 2, 3, or 4.

5. Align red paper dot on the collar receiver against the red dot on the hand-held transmitter, in order to place the collar in a program mode. Hold dots together for 5-8 seconds. The light on the collar receiver will glow solid, go out then change to yellow.

Match components by separating units by a foot or more, then pressing and holding any of the stimulation buttons. When light on collar pulsates red, release buttons. Matching process is complete.

Step 6 Test your fence

You should have your boundary wire laid out and properly connected. DO NOT test the system on your dog.

1. Adjust containment field

Move the FIELD WIDTH knob to the 9 o'clock position.

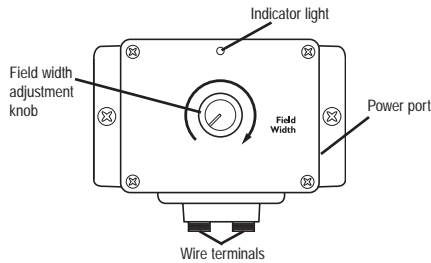

2. Test system.

Select a section of straight boundary wire that is at least 50 feet long. Select containment mode (for SD-3000/SD-3100 models only). Attach the supplied test light to the receiver probes and hold the collar receiver at your dog's neck height. Slowly walk the collar toward the boundary wire. Listen for the warning tone and watch for the test light to light. The wider you can make the containment field, the less chance your dog can run through. Adjust the FIELD WIDTH as necessary and test again.

Test in a number of different areas until you are satisfied there are no wire breaks and the system is functioning properly.

Next walk all around the "safe" part of the yard to ensure there are no stray signals, particularly near the twisted wire coming from the transmitter. Test collar in and around the inside of the house as well. As mentioned prior, signals from Cable TV, electrical or telephone lines can "couple" causing stray signals inside and outside the house that can activate the dog's collar accidentally. If you do encounter this phenomenon, your boundary wire is probably too close to these outside lines and will need to be moved or modified. Containment collars should not be worn inside the house.

Step 7 Bury your wire

You may need the following tools for efficient installation: Straight edge spade or a gas powered edger. If you plan on running the wire across a driveway you may also need a caulk gun, silicone caulking and a circular saw with a masonry blade.

1. Ensure system is turned off

Turn off the transmitter and unplug the adapter from the AC outlet.

2. Bury the wire

Dig a trench 1"-3" deep with a flat edge spade or gas-powered edger. A 30 - 45 degree angle cut will be the easiest to close and keep the wire in the trench. Make sure there is a little slack in the wire as you bury it to compensate for expansion and contraction due to temperature changes.

When crossing an asphalt driveway, make a 1/4" cut across the driveway using the circular saw and masonry blade. Place the wire in the crack and seal with asphalt sealant. In concrete there is usually an expansion joint that can be cleaned out and used for the same purpose and covered with clear silicone caulk.

The wire can be placed underwater in creeks and streams by running the wire through PVC pipe or length of garden hose to prevent the wire from being damaged.

3. Place training flags

Repeat the test system step outlined in the prior page. As soon as you hear the warning tone, place one flag. Repeat the process every 10' interval around the containment area. The flags will be your dog's visual clue to the boundary during training and will be removed during the training process.

Step 8 Train your dog

Watch the training video and follow the training steps outlined in the separate Training and Troubleshooting Guide. You may see your dog respond immediately to the training, however continue to follow the enclosed Training Guide to fully train your dog. The convenience that your new fence offers plus the added safety for your dog are well worth the time invested

